



Designed with assistance from medical professionals

**For Cardiovascular &
Muscular Skeletal Health**

Vitality Series

Service and Technical Support

For technical assistance or warranty service requests, please call a technical support representative at 844-894-6659. Factory trained technical support representatives are available Monday - Friday from 9:00 am to 5 pm EST.

The components vary by model. Providing photographs expedites resolution and increases accuracy of diagnosis. *If you are calling to request replacement cabinet pieces*, before you call please take pictures of the damaged cabinet area and the topside controls. *If you are calling for technical or operating assistance*, please take pictures of topside controls, the GFCI wiring and breaker installed by your electrician. You should be prepared to email the pictures to the technical support representative while you are on the phone. Your serial number sticker is located either on the filter canister or on the bottom of the filter basket. Please have the following information, most of which can be found on the original purchase invoice, when you call.

Spa Model _____

Spa Serial Number _____ Date of Purchase _____

Dealer Name _____

Approximate Date of Spa Installation _____

Read, Carefully Follow, & Keep these Instructions !



Providing Therapy for Life

For help, please call 844-894-6659

INDEX

Technical Support Information.....	2
Warnings and Hazards.....	4
Site Prep and Installation Recommendations.....	10
Electrical Requirements and Recommendations.....	14
Glossary of Components.....	18
Filling the Spa with Water.....	22
Topside Control Instructions	26
Topside Control Error Codes.....	33
Water Chemistry Basics.....	34
Caring for your Spa.....	43
Troubleshooting Water Chemistry.....	46
Troubleshooting Guide.....	48
Manufacturer’s Warranty.....	51



Providing Therapy for Life

For help, please call 844-894-6659

HAZARDS TO UNATTENDED CHILDREN!

RISK OF CHILDREN DROWNING.

Extreme caution must be used to prevent unauthorized access by children. To avoid accidents, ensure that children cannot use the spa unless they are supervised at all times. To reduce risk of injury, do not allow children to use this product unless they are closely supervised at all times. To reduce the risk of injury, lower water temperature when spa is used by children. Lower water temperatures are recommended since children are especially sensitive to hot water.

ALWAYS:

Make sure child resistant locks on the spa cover are engaged after use for your children's safety. Every Dr. Wellness Spa is equipped with a locking cover that meets the ATSM F1346-91 Standard for Safety Covers. There is no representation that the use of the cover, locking clips or actual locks will not prevent access to the spa.

Test the water temperature with your hands before allowing children to enter the spa to be sure that it's comfortable. Children are especially sensitive to hot water.

Remind children that wet surfaces are slippery. Make sure that children are careful when entering and exiting the spa.

Check with local authorities regarding fencing requirements for spas in your area.

NEVER:

Allow children or pets on the spa cover. Most spa covers have a maximum weight load of 20 lbs. Covers are strong enough to withstand the weight of less than one foot of snow. They are not designed to support the weight of people or pets. Sitting on the cover may cause the foam inserts to break.

Allow children to have unsupervised access to the spa. Children should always be in the company of a responsible adult to make sure children do not have access to the spa.



AVOIDING THE RISK OF ELECTROCUTION

YOUR DR. WELLNESS SPA MUST BE INSTALLED BY A LICENSED ELECTRICIAN.

To ensure the spa functions properly and to ensure your warranty is not compromised by improper installation, you must have a licensed electrician install all electrical components. Connect only to a grounded source. Install a minimum of five feet (1.5m) from any metal surfaces. A ground terminal (pressure wire connector) located inside the control box must be used to permit connection with solid copper bonding conductors between the control box and any metal equipment, metal water pipe, metal enclosures of electrical equipment, or conduit within five feet (1.5m) of the spa.

Do not permit any electrical appliances, such as lights, telephones, MP3 players, radios or televisions within five feet (1.5m) of the spa unless they were built in by the manufacturer. Failure to maintain a safe distance may result in death or serious injury from electrocution if the appliance should fall into the spa.

WARNING

Your spa requires a Ground Fault Circuit Interrupter for user and equipment protection in compliance with section 680-42 of the National Electrical Code, ANSI/NFPA 70-1993. To ensure your safety, you should inspect the Ground Fault Circuit Interrupter before each use to be sure it is functioning properly, in good condition and that the wiring is connected properly .

ALWAYS:

Make sure your spa is properly connected - *ALL ELECTRICAL CONNECTIONS MUST BE INSTALLED BY A LICENSED ELECTRICIAN*
Disconnect the spa from the power supply before draining and servicing components.

Test the Ground Fault Interrupter(s) before each use.

Replace damaged wires and cords immediately to reduce the risk of electric shock. Failure to do so may result in death or serious permanent injury by electrocution.



Providing Therapy for Life

For help, please call 844-894-6659

NEVER:

Use the spa with the equipment compartment door removed.

Replace components except with identical components supplied by the manufacturer.

Operate audio or video equipment while inside the spa unless it was installed and provided by the manufacturer. Do not connect auxiliary components (i.e. headphones) to the system.

Place electrical appliances within five feet (1.5m) of the spa.

Attempt repairing the spa control box without assistance from our technical support team. Without proper instruction, you should not attempt to service the parts inside the spa control box.

AVOIDABLE INJURIES

Suction Fittings and Grates

Keep all loose articles of clothing, hair or hanging jewelry away from suction fittings, suction grates, rotating jets or other moving components. The suction fittings in this spa are sized to match the specific water flow created by the pump. If it is necessary to replace the suction fittings or grates, be sure the flow rates are compatible. Never replace suction fitting with one rated less than the flow rate marked on the original suction fitting. Because of the risk of injury, never operate the spa if the suction fittings are broken or missing. Please contact technical support at 844-894-6659 for service, replacements or repair.

Filters and Skimmers

Never operate the spa if the filter(s), filter lid(s) or skimmer(s), skimmer assembly(s) or weir(s) are missing. Do not remove floating weir(s), basket(s) or filter(s) while spa is running. Please contact technical support at 844-894-6659 for service or repair.

Wet Surfaces

Exercise care when entering and exiting the spa. Wet surfaces can be slippery.

Increased Side Effects of Medication

The use of drugs, alcohol, or medication before or during spa use may lead to unconsciousness with the possibility of drowning.



Anyone using medication should consult a physician before using a spa; some medication may cause a user to become drowsy, while other medication may affect the heart rate, blood pressure or circulation. Anyone taking medications which induce drowsiness, such as tranquilizers, antihistamines or anticoagulants should not use a spa.

YOU SHOULD CONSULT YOUR PHYSICIAN IF YOU ARE:

Pregnant or possibly pregnant.

Suffering from obesity or have a medical history of heart disease, low or high blood pressure, circulatory problems, infectious diseases, immune deficiencies, infectious diseases, infections skin irritations, or diabetes should consult a physician before using a spa.

Maintaining Well Balanced Water Chemistry

Always shower before and after using a spa. To reduce the possibility of contracting a waterborne illness, always maintain water chemistry within the parameters in this manual. Keep the water clean and sanitized with correct chemical balance to help maintain safe water and prevent possible damage to spa components and bathers. If other bathers are negatively affected, discontinue use and consult a physician. The recommended levels for your Dr. Wellness Spa are:

Free Available Chlorine (FAC):	3.0 to 4.0 ppm
Free Available Bromine (FAB):	2.0 to 4.0 ppm
Total Alkalinity	80 to 120 ppm
Water pH	7.2 to 7.6
Calcium Hardness	150 to 250 ppm

Refer to Water Chemistry and Maintenance section for further information and complete instructions about water and spa care.

REMEMBER, WHEN ADDING CHEMICALS:

Turn the primary pump on for at least ten minutes after adding any spa water chemicals into the filter compartment.

Replace or clean the filter cartridge to remove debris and mineral buildup which may affect the performance of jets, limit the water flow, or trip the high limit thermostat which will automatically turn off the entire spa to prevent further damage to the spa.



Providing Therapy for Life

For help, please call 844-894-6659

AVOIDING THE RISKS OF HYPERTHERMIA

Prolonged immersion in hot water can result in HYPERTHERMIA, a dangerous condition occurring when the internal temperature of the body reaches a level above normal (98.6°F). The symptoms of hyperthermia include unawareness of impending hazard, failure to perceive heat, failure to recognize the need to exit the spa, physical inability to exit the spa, fetal damage in pregnant women, and unconsciousness resulting in a danger of drowning. The use of alcohol, drugs or medication can greatly increase the risk of fatal hyperthermia.

TO REDUCE THE RISK OF INJURY FROM HYPERTHERMIA:

The Consumer Products Safety Commission has stated that the water in the spa should never exceed 104°F (40°C). Water temperatures between 100°F (38°C) and 104°F (40°C) are considered safe for a healthy adult. Lower water temperatures are recommended for extended use (exceeding 10 minutes) and for young children. Extended use at higher temperatures can cause hyperthermia. Pregnant or possibly pregnant women should limit spa water temperatures to 100°F (38°C). Failure to do so may result in permanent injury to your baby. If you are or may be pregnant, you should consult with a physician before using a spa.

Always:

Remove all jewelry and put long hair in a bathing cap or hair tie before you enter the spa.

Measure the water temperature with an accurate thermometer before entering the spa to verify the digital thermometer displays the correct temperature. The tolerance of regulating devices may vary as much as +/- 5°F (2°C).

Test the water with your hand to be sure it's comfortable before entering the spa.

Never:

Sit on or block access to the filter access or suction drains.

Allow glass or other breakable objects in the spa area.

Use alcohol or drugs before or during spa use. Stay well hydrated and drink plenty of water.

Stay in the spa for extended periods of time. If you are going to be in the spa for more than 10 minutes, you should reduce the temperature of the spa to 100°F (40°C) or lower.



Use a spa immediately after strenuous exercise.

Use the spa alone.

Allow anyone in the spa if they have an infectious disease.

SPA COVER SAFETY

When the spa is not attended by an adult, the cover should be on with all locks secured whether it is empty or filled with water. Because heat retentive materials are used to insulate the spa for efficient operation, an uncovered spa surface with exposure to sunlight, rain, snow and high temperatures may cause permanent damage to the spa. Damage caused by exposing the spa to this abuse is not covered by the warranty.

ALWAYS:

LEAVE THE COVER PARTIALLY OPEN FOR 20 MINUTES WHEN ADDING CHEMICALS to allow chemical vapor to escape. Do not leave the spa unattended when the cover is off.

Brush heavy snow loads off the cover with a soft brush. Spa covers are not designed to hold weight loads of more than 20 pounds.

Reinforce your cover with wind straps during periods of high wind. The tie downs will not hold your cover in place if wind speeds are excessive.

After cleaning, wipe the vinyl with a non-alcohol based vinyl protector. Alcohol and Chlorine based cleaners will break down the vinyl and stitching over time. Harsh and or abrasive cleaners of any kind will damage the UV protective coating in the vinyl.

Use only approved and recommended accessories, chemicals and cleaners.

NEVER:

Leave the swim spa unattended when the cover is off.

Place heavy objects on, stand on or allow children or pets to sit or stand on the spa cover.

Lift or drag the cover by using the cover skirt or tie downs. Always lift or carry the cover by using the handles.

Use sharp objects near your spa cover. Sharp objects may puncture the vinyl and/or plastic allowing the foam inserts to get heavy.

Use harsh chemicals to clean the cover. Excessive chemical use damages the spa cover.



Providing Therapy for Life

For help, please call 844-894-6659

CHOOSING A LOCATION

Proper placement of your spa is key not only to enjoying it, but also maintaining it. Wherever you choose to place your swim spa, there are some basics that must be followed. Planning and preparing are critical for long term care and enjoyment.

MAKE SURE THE INSTALLATION MEETS YOUR LOCAL CODES, covenants and restrictions. Many communities require that swim spa installations be done with the same security precautions, like fences with locking gates, as swimming pools.

MAKE SURE THE LOCATION IS FREE OF OBSTACLES THAT MAY INTERFERE WITH DELIVERY AND INSTALLATION. The overall dimensions are an important consideration when planning for delivery & installation. A clear pathway from the curb to the installation site makes delivery a breeze. The pathway should be free of obstruction from things like walls, fences, tree limbs, heat pumps, and power lines. Check to be sure gate openings are wide enough for the spa to pass through without damaging the spa.

NORMAL USE OF YOUR SPA WILL MEAN LOTS OF SPLASHING. Choose a location that allows the splashing water to easily drain away from the base of the spa rather than pooling around the spa. Additionally, close proximity to a water hose will allow you to easily top off the spa after each use.

CONSIDER THE PROXIMITY TO THE DOORS OF THE HOUSE, ESPECIALLY IN COLD WEATHER. Be sure there is a pathway to the spa that can be easily maintained in inclement weather.

KEEP YOUR SPA AWAY FROM LANDSCAPING SPRINKLERS, ROOF OVERHANGS AND GUTTERING. Eliminating water that drains away from the spa's foundation is important. But you should also consider the negative effects of wind, exposure to the sun and the location of trees to minimize the effects of falling debris, excessive sunlight and shade.

CHOOSE A LOCATION THAT ALLOWS EASY ACCESS FOR MAINTENANCE AND REPAIRS. You should leave 36" of clearance on the side of the spa with the electronics and 24" of clearance on all other sides to allow easy access for maintenance and repairs. Some periodic maintenance steps require access to the electrical equipment area.



MANUFACTURER'S RECOMMENDED GENERAL INSTALLATION INSTRUCTIONS

The manufacturer's preferred method of installation for your swim spa should be followed exactly. Failure to follow these instructions will result in structural damage to the spa that is not covered under your warranty. It's very important that you follow the manufacturer's guidelines and hire a reputable licensed contractor for site preparation and leveling of your new Dr. Wellness Swim Spa.

GENERAL INSTALLATION GUIDELINES

THE MANUFACTURER DOES NOT RECOMMEND IN GROUND OR PARTIAL IN GROUND INSTALLATION. When swim spas are installed below grade, there is no access for repairs and structural modifications may be required. Making modifications to the structure will void your warranty.

SITE PREPARATION

The manufacturer recommends that your swim spa be installed on a level, concrete pad reinforced with steel bars. When your spa is filled with water and bathers, it may weigh over 4 tons, depending on the model you choose. The concrete pad should be engineered to hold a minimum of 950 pounds per square foot.

Before you begin your site preparation, contact your local gas, electric and cable companies to be sure there are no underground lines in the site you have chosen. For best results, the site preparation should begin with digging an area that is at least 8" wider and longer than the overall dimension of the spa. This site should be leveled and 8" to 12" deeper than the final desired elevation of the spa. Depending on the depth of the site, the area should be filled with between 4" and 6" of crushed stone, followed by 3/8" steel reinforcement bars on a 16" grid, then 4" to 6" of poured concrete. Level the concrete and finish with a course broom to ensure it is slip resistant.

IF YOU LIVE IN A CLIMATE WITH FREEZE/THAW ZONES, or that is prone to ground shift because of the kind of dirt or low water tables, we recommend installing poured concrete footings that extend below the freeze line or water table prevent the possibility of shifting.



Providing Therapy for Life

For help, please call 844-894-6659

MAKE SURE THE SITE IS AWAY FROM AREAS THAT ARE PRONE TO FLOODING or standing water and there is adequate drainage away from the spa. Never backfill the sides of the spa with dirt. If necessary, you should incorporate a retaining wall into the site design that will help ensure the cabinet and electrical components remain dry at all times.

IF YOUR SITE PLAN INCLUDES DECKING to give the appearance the spa is recessed, you should choose slip resistant materials for everyone's safety. Water splashing onto the surrounding surface is a normal and should be taken into consideration when choosing decking materials. You should also design the deck to include removable or locking, hinged panels to allow easy access on all four sides for maintenance and service. Remember, making the spa accessible for service is not covered under the warranty.

IF YOU ARE PLACING YOUR SPA INDOORS you should plan well in advance to prevent the delivery and installation issues that will occur when attempting to get the spa indoors. A licensed contractor can ensure the load bearing capacity of the floor is adequate, make modifications like increasing the size of the entry point, verify the ceilings are high enough, install a floor drain to eliminate standing water, and add a convenient water supply so the water level can be properly maintained. Planning these things in advance of delivery will simplify the installation process and your enjoyment.

Floor coverings should be slip resistant with some ability to grip when the floor is wet. The location and floor covering must be able to handle draining all of the water which is part of routine maintenance. You should consider installing a ventilation system. Humidity and moisture should be considered. When the cover is on the spa, very little moisture escapes. If floor coverings trap water or the drainage is inadequate, wood, paper, and drywall, may get damp creating mold and mildew over time. Some spa chemicals may have an adverse reaction to some household metals.

AGAIN, ADEQUATE LOAD BEARING CAPACITY FOR THE WEIGHT OF THE SPA WHEN FILLED WITH WATER AND BATHERS IS VITAL.
PREPARING FOR THE DELIVERY AND OFF LOADING YOUR SWIM SPA

It is important to speak with your sales representative about what to expect at the time of delivery well in advance of the delivery date so you can plan and be prepared on the day of delivery. Failing to adequately prepare in advance will result in delayed delivery. Your swim spa leaves the manufacturing facility wrapped with protective materials, shrink wrapped with the bottom of the spa banded to a wooden pallet.



IF YOUR SWIM SPA WAS PURCHASED FROM A LOCAL DR. WELLNESS DEALER and you arranged for delivery at the time of purchase, in most cases your spa will arrive on a flat bed truck or low profile trailer.

IF YOUR SWIM SPA IS SHIPPING FROM THE MANUFACTURING FACILITY, it will arrive in a 53' common carrier closed box trailer. It is a good idea to find a local towing service with a tilting flat bed and a winch to gently pull and remove the spa from the closed box trailer onto the flatbed. You may want to consider meeting the towing service at the carrier's destination terminal to inspect the spa and allow the carrier to use their equipment to move the spa onto the flat bed. It is typically more efficient to coordinate a convenient delivery schedule for all service providers and will eliminate additional expenses service providers may charge if the carrier is late for the delivery appointment.

THE MANUFACTURER'S PREFERRED METHOD OF PLACEMENT IS A QUALIFIED CRANE SERVICE.

CRANE SERVICE IS NOT INCLUDED IN THE PURCHASE OR DELIVERY PRICES.

THE MANUFACTURER RECOMMENDS THAT YOU CHOOSE A REPUTABLE CRANE SERVICE WITH SPA REMOVAL EXPERIENCE. Consider what happens to the contents of a box when you shake and squeeze the box. What's inside the box may move or break without your knowledge until you open the box. Now, think of your swim spa as the same box. If the spa is not properly stabilized or if the straps are too tight or improperly placed, the spa components and structure may be compromised or broken, even if there is no visible damage to the spa, just like the box and its contents. Crane services who are familiar with spa removal and placement know how to properly place spreaders and straps, ensuring the frame is adequately supported during removal and installation. Both the box and the contents will be protected from damage by an experienced crane service. The crane service you choose should be able to provide insurance that will cover the cost of damage to the spa and/or your property during removal and installation if requested.

NEVER PUT THE SPA ON ITS TOP OR SIDES. NEVER FLIP THE SWIM SPA END OVER END. The swim spa should always be moved with the side that was on the pallet side facing down to prevent damage to the structure, the acrylic and the components, .

YOUR WARRANTY DOES NOT COVER DAMAGE TO THE SPA THAT IS THE RESULT OF IMPROPER REMOVAL OR INSTALLATION OF THE SPA.



Providing Therapy for Life

For help, please call 844-894-6659

LEVELING YOUR SWIM SPA

You should verify the entire spa completely level when it has been positioned into place.

DO NOT USE SHIMS TO LEVEL THE SPA. Using shims will create pressure points that will damage the spa structure.

ELECTRICAL REQUIREMENTS AND INSTALLATION

ALL ELECTRICAL CONNECTIONS MUST BE PERFORMED BY A QUALIFIED LICENSED ELECTRICIAN IN ACCORDANCE WITH THE NATIONAL ELECTRIC CODE (NEC) FOLLOWING STATE AND LOCAL ELECTRICAL CODES IN EFFECT AT THE TIME OF THE INSTALLATION.

Connecting the spa to an improperly wired circuit will eliminate many of the spa's built in safety features which may result in fire, electrocution, or other risk of injury. Damages to the spa which are the result of improper wiring are not covered under the manufacturer's warranty and will terminate all listings from independent listing agencies.

THE ELECTRICAL SUPPLY FOR YOUR SWIM SPA MUST BE HOUSED IN A WEATHERPROOF SERVICE BOX AND INCLUDE A SUITABLY RATED SWITCH AND GROUND FAULT CIRCUIT INTERRUPTER between the main service entrance and the spa to open all ungrounded supply conductors in compliance with Section 422-20 of the National Electrical Code/USA, ANSI/NFPA/70 and in compliance with independent listing agencies. This might be used as a shut off switch, and must be installed so that it is accessible to the spa occupants, but not within 5 feet (1.5m) of the spa.

THE WIRING SPECIFICATIONS IN THIS MANUAL are for standard installations where the main power supply is within 40 feet of the spa. If the main power supply is more than 40 feet away, the electrician should make appropriate modifications.

The electrical diagrams contained in this manual and inside the spa control box are included as a guideline for the licensed electrician installing the electrical connections and may vary by model. Please refer to the wiring diagram inside the spa control box for model specific connection instructions. All wiring connections must be watertight.



ALL CONNECTIONS MUST BE MADE USING COPPER CONDUCTORS ONLY. Do not use aluminum wire. Connection wires, circuit breakers, and/or fuses, must all be sized to accommodate the Total Ampere load.

NEVER TURN POWER ON TO THE SPA WHEN IT IS NOT FILLED WITH WATER. DO NOT connect power to the empty spa. When power is supplied to the spa, it automatically activates critical components within the spa, such as the pumps, controls and the heating. If power is supplied to the components before it is filled with water, the components may be damaged instantly. Damage that occurs to the spa because power was supplied before it is filled with water is not covered by the manufacturer's warranty.

PRIOR TO PERFORMING ANY SERVICE TO YOUR SWIM SPA, TURN OFF ALL PRIMARY ELECTRICAL EQUIPMENT AT THE MAIN CIRCUIT BREAKER OR DISCONNECT PANEL. Your spa must be permanently connected (hard wired) to a power supply that is protected by a Ground Fault Circuit Interrupter (GFCI). Power supplied to your Swim spa must be a dedicated circuit with no other appliances, lighting, or any other electronic components powered by this circuit.

Do not permit any electrical appliances, such as lights, telephones, MP3 players, radios or televisions within five feet (1.5m) of the spa unless they were built in by the manufacturer. Failure to maintain a safe distance may result in death or serious injury from electrocution if the appliance should fall into the spa.

All metal components or accessories that are permanently installed like handrails, ladders, drains and hardware that are within 5 feet (1.5 m) of the spa must be bonded to the equipment grounding bus with copper conductors no smaller than No. 6 AWG.

WIRING REQUIREMENTS

The minimum wire size for 50 amp & 60 amp systems is # 6/3 c/w ground (6 gauge/4 conductor) if the main power supply is within 40 feet of the spa. If the main power supply not within 40 feet, your electrician should make the appropriate modifications.

The spa must have dedicated 230V service from the main power supply. Do not attempt to share service with other appliances. Use only a class 'A' double-pole Ground Fault Circuit Interrupter (GFCI).

To access the spa controls, remove the cabinet panel and store it safely. Do not replace the access panel until the spa is filled with water and you are sure it is operating properly.



Providing Therapy for Life

For help, please call 844-894-6659

WIRING SCHEMATICS

INSTALLATION OF THE GFCI AND CIRCUIT BREAKER, INCLUDING AMPERE SIZING AND SELECTION OF CONDUCTOR SIZE AND TYPE MUST BE PERFORMED BY A QUALIFIED, LICENSED ELECTRICIAN IN ACCORDANCE WITH THE NATIONAL ELECTRICAL CODE, AND ALL FEDERAL, STATE AND LOCAL CODES AND REGULATIONS IN EFFECT AT THE TIME OF INSTALLATION. WIRING SCHEMATICS ARE PROVIDED AS A REFERENCE AND ARE INTENDED ONLY FOR USE ONLY BY QUALIFIED, LICENSED ELECTRICIANS.

MODEL SPECIFIC HARD WIRING INSTRUCTIONS ARE LOCATED INSIDE THE SPA CONTROL BOX.

ELECTRICAL CONNECTIONS

IF YOUR ELECTRICIAN HAS QUESTIONS ABOUT THE WIRING INSTRUCTIONS, please call Dr. Wellness Spas Technical Assistance prior to starting installation at 844-894-6659. Factory trained technical service specialists are available to answer questions during their normal business hours, Monday through Friday from 9:00 am to 5 PM EST.

CORRECT WIRING OF THE ELECTRICAL SERVICE BOX, GFCI box and pack terminal block is required. Your spa requires a 4-wire, 50 amp or 60 amp (depending on the spa model), 230 volt subfeed in non metallic pipe to the spa equipment compartment.

THE BLACK AND RED WIRES from the electrical box must be connected to the input of the GFCI.

THE WHITE WIRE from the electrical box must be connected to the neutral bus.

THE GREEN OR COPPER WIRE must be connected to the ground lug of the GFCI.

THE BLACK, RED AND WHITE wires going to the spa must be connected directly to the output of the GFCI.

THE NEUTRAL TO THE GFCI must be connected to the neutral bus.

THE GREEN OR COPPER WIRE going to the spa must be connected to the ground lug.

HARD WIRE THE SPA CONTROLS FOLLOWING THE MODEL SPECIFIC DIAGRAM INSIDE SPA CONTROL BOX LID. The spa controls are inside the access panels labeled **"REMOVE THIS PANEL FOR ELECTRICAL"**. In most models, the panel is underneath the spa's top side control pad.



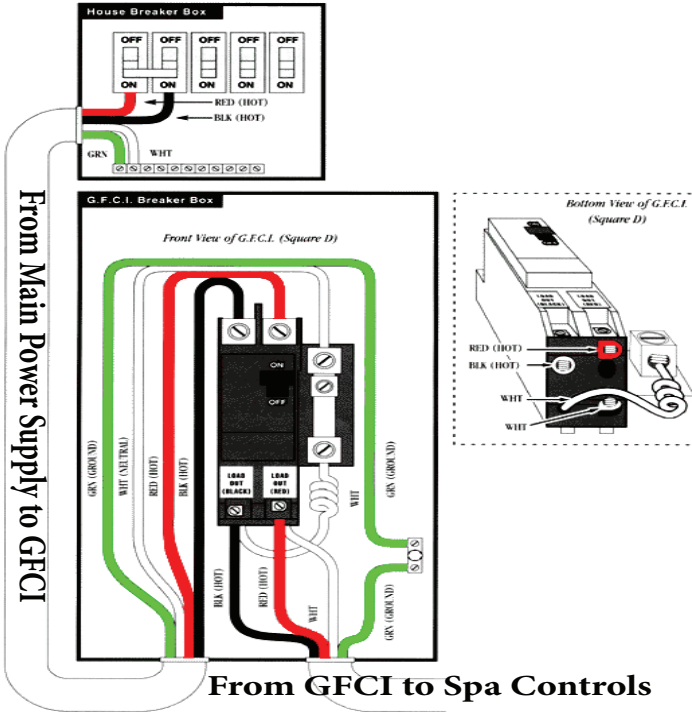

Important!!
 The white neutral wire from the back of the GFCI **MUST** be connected to an incoming service neutral. The GFCI will not work without it. The incoming white neutral wire is not properly connected, the GFCI will automatically trip. If the GFCI trips when you power on the spa, you should make sure the neutral wire is properly connected.



Providing Therapy for Life

For help, please call 844-894-6659

THE SPA PACK IS THE COMPUTER THAT CONTROLS THE SPA. Pressing buttons on the topside controls triggers a reaction in the spa pack. When the “jets” button is pressed, the spa pack communicates with the pump, telling it to turn on forcing water into the spa through the jets. When the water temperature falls too low, the spa pack communicates with the heater and pump, turning the heater on and water begins circulating until the desired temperature is reached. The spa pack is designed to automatically take care of many of the maintenance and safety features so you don’t have to.

UNLESS YOU ARE ASKED TO DO SO BY A TECHNICAL SUPPORT REPRESENTATIVE, you should not remove the cover on the spa pack. If you are asked to remove the cover on the box, you should manually turn the GFCI “off” before removing the cover. You may be asked to email pictures of the inside of the control box to allow faster diagnosis and resolution service issues.

THE TOPSIDE CONTROL IS LIKE THE KEYBOARD FOR A COMPUTER. It allows you to change what the spa does by pressing buttons. Temperature, filtration, energy consumption and jet functions are all controlled by pressing the buttons on the spa controls. The options offered on the spa controls will vary depending on the model purchased. Please refer to the model specific controls for detailed instructions.

ERROR CODES ON THE TOPSIDE CONTROLS WILL ALERT YOU TO PROBLEMS DETECTED BY THE SPA PACK. Error codes are often eliminated by turning the GFCI “OFF” for 30 minutes and then turning the GFCI back “ON”; If you receive an error message, please refer to the model specific error message section of the manual and follow the instructions or call a technical support representative at 844-894-6659 for additional assistance.

THE SPA HEATER WARMS THE WATER IN THE SPA. When the water temperature falls below the allowed temperature range, the pack relays a message to the heater to increase the water temperature. While the heater is on, the water circulates until the correct temperature is reached. The heater and pumps will turn on and off automatically to maintain temperature settings.

YOUR SPA CONTROLS WILL NOT COOL THE WATER. If you want to lower your water temperature, you should partially remove the cover for a short period of time allowing heat to escape or drain some of the water from the spa and add cool water. If you drain water from the spa, you should manually turn the GFCI “off” and follow the instructions for filling your spa.

SPAS ARE DESIGNED TO KEEP WATER WARM AND INSULATED AGAINST HEAT LOSS. If the water temperature is set lower than the



ambient temperature, and the ambient temperature does not decrease enough to cool the water in the spa, the temperature of the water in the spa may be higher than the programmed temperature setting.

THE DRAIN BIB is used to remove the water from the spa. Because the water capacity in your Swim spa is very high, submersible sump pumps are a faster, more effective way to drain the water. Instructions for using the drain bib are on page 37. The drain is located near one corner at the base of the spa. Check to be sure the drain bib is closed and no water is draining from it when you fill the spa. Always dispose of spa water in accordance with local requirements. Some communities regulate the disposal of excess water in storm drains and water shed areas because excessive chemicals in spa water can be hazardous to the environment.

THE SPA PUMP(S) push water through the plumbing lines into the jets. Pumps are turned on and off by pressing the button(s) on the topside controls. The number and speed of the pumps varies by spa model.

THE PUMP IS DESIGNED TO PUMP WATER, NOT AIR. If air is in the pump or the plumbing lines, the air will prevent circulation of the water. Letting your pumps run with an air lock instantly destroy the pump(s). Filling the spa properly or “bleeding” the pump prior to powering the spa on will help prevent air locks. If you hear a “humming” sound, if the jets don’t work or the jets only work in part of the spa when you press the pump button, it is likely you have an air lock and need to bleed the pump. To bleed the pump, manually turn the GFCI “off”. To release the air lock, turn the bleed valve (thumb screw) on the base of the pump counter clockwise until water trickles from the pump. When water begins to trickle, turn the bleed valve counter clockwise to tighten. Do not over tighten. Do not use tools to turn the bleed valve because it may break the thumb screw.

THE SLICE VALVES (“T” Stems) are in the plumbing lines near the pump(s) so the spa can be serviced without draining the all of the water from the spa. When the spa is serviced, the lock is removed and the “T” stem is pushed down creating a seal between the “T” stems. When service is complete, the “T” stems are raised and locked in the up position.

Make sure the slice valves are locked in the “up” position before power is applied to the spa. If the spa is on and the slice valves are closed it will immediately damage the spa. Each time you change the water in the spa, you should check to be sure the locks on the slice valves are in good condition; locks should be replaced if they will not hold the “T”stem in the “up” position. Do not use the spa until the locks have been replaced.



Providing Therapy for Life

For help, please call 844-894-6659

THE PLUMBING UNIONS CONNECT THE PLUMBING LINES to the spa components. Unions loosen in transit and when seasons change. During the initial installation and each time you drain your spa, you should hand tighten all plumbing unions.. The main cause of leaks inside the spa cabinet is plumbing unions that need to be tightened. Do not use tools or overtighten plumbing unions

THE FILTER ASSEMBLY consists of the filter, the filter basket and the weir. The filter basket catches large debris, the filter catches fine particulates and oil. You should check the filter assembly on a regular basis making sure the basket is free of debris and the filter is in good condition. If the filter assembly is obstructed, flow will be restricted and damage the spa. Using the spa without the filter assembly in place is a drowning hazard and may damage the spa. If any part of the filter assembly is damaged, do not use the spa until it has been replaced. Please call technical service at 844-894-6659 for replacement parts. Before removing the filter assembly to fill the spa or change the filter, manually power the GFCI “OFF”. Turn the weir counter clockwise until it stops. Lift the weir, raise and remove the basket. Lift the filter from filter housing. Replace the filter, basket and weir. Turn the filter assembly clockwise until it stops and is locked in place. The manufacturer recommends that you replace the filter every three months. To prevent air in the plumbing lines, you should soak new filters in water for 30 minutes before installing.

THE SUCTION DRAIN COVERS are on the sides and in the foot well of the spa. They are caps that cover the suction drains to help prevent risk of drowning and that prevent debris from being sucked into the plumbing lines. If the suction drain covers are obstructed, flow is restricted which can damage your spa. Keep hair, clothing and children away from the suction drains when using the spa. It is important to check them on a regular basis making sure they are good condition Do not use the spa if they need to be replaced. Replacement parts can be obtained by technical service at 844-894-6659. You should avoid contact with the suction drain covers when the GFCI is powered “on”.

THE DIVERTER VALVE is a large rotating dial on top of the acrylic surface used to control flow of the water between sections of the spa controlled by each pump in the spa. The diverter valve rotates right and left. The diverter valve has built in “stops”. Do not force the diverter valve past its natural stopping point. If there is excessive pressure in the plumbing lines, turning the diverter valves will be difficult when the jets are turned on. Turn the jets off and rotate the diverter valve back and forth, then turn the jets back on. Forcing the valve to turn past it’s built in “stop” or when there is excessive pressure in the lines will damage the spa. When the



diverter valve is positioned in the center, water flow will be spread evenly throughout each area of the spa controlled by a diverter valve. Turning the diverter valve all the way to one side will restrict the water flow from one section and force all of the flow into the other section. Turning the diverter valve all the way to the other side will reverse the flow of water to the opposite side of the spa. **THE AIR VALVE** is a smaller rotating valve on the acrylic surface of the spa that looks like a smaller diverter valve. It is used to increase or decrease air flow through the jets. Increasing air flow creates “bubble action” in the spa. The air valve rotates right and left. Do not over turn the air valve which has built in “stops”. Forcing the valve to turn past it’s built in “stop” will damage the spa. When the air valve is positioned in the center, there is moderate air flow with moderate “bubble action”. When the air valve is turned to one direction, or closed, there is less air flow and fewer bubbles. If the air valve is turned fully to the opposite direction, the air valve is fully open creating the most bubbles.

THE WATERFALL VALVE IS USED TO INCREASE OR DECREASE FLOW THRU THE WATERFALL. The waterfall valve rotates right and left. Do not over turn the waterfall valve which has built in “stops”. Forcing the valve to turn past it’s built in “stop” will damage the spa. When the waterfall valve is placed in the center, there is moderate flow through the waterfall. If the valve is turned all the way in one direction, there is no flow through the waterfall. If the valve is turned all the way in the opposite direction, the flow is increased to allow maximum flow through the waterfall.

PREPARING THE SPA FOR USE

Your spa has been tested during the manufacturing process. There may be some water remaining in the plumbing lines after testing leaving spots on the acrylic or cabinet. Wipe the spa and cabinet with a clean soft rag. Do not use household cleaners that contain bleach or ammonia (including most glass cleaners) because they will have an adverse effect on the surfaces of the spa and do not mix with chemicals used to maintain water chemistry. Never use abrasive cleaners on the cabinet, cover or acrylic surface. They may do permanent, irreversible damage. With the drain bib open, rinse the inside of the spa with clear water. With the filters removed and the drain valve open, run water through the filtration canister and jet lines until the water coming from the drain bib runs clear. This will remove any incidental dust, dirt and debris that may have accumulated during shipping and installation.



Providing Therapy for Life

For help, please call 844-894-6659

FILLING THE SPA WITH WATER

MAKE SURE THE GFCI IS TURNED “OFF”. Never attempt any kind of service or cleaning when power is applied to the spa. Each time you remove the spa cabinet for any reason, manually turn the GFCI off.

NEVER LEAVE THE SPA UNATTENDED while the exterior panels or cover are off the spa.

REMOVE THE ACCESS PANEL MARKED “REMOVE THIS PANEL FOR ELECTRICAL”. In most models, the access panel is underneath the spa’s top side controls. Remove all of the screws that attach the access panel to the spa frame. Check for obvious signs of damage inside the cabinet including loose wires or broken pipes. If you see damage inside the spa cabinet, call a technical service associate at 844-894-6659 for assistance and repair

HAND TIGHTEN THE PLUMBING UNIONS and check to be sure the slice valves are locked and in the “up” position. If the slice valves are not in the up position, pull the “T” stem all the way up to open the slice valves. Lock the “T” stem and attach the clip locks. Never operate the spa when the slice valves are closed. Damage that occurs because the spa was powered on when the slice valves were closed is not covered by the manufacturer’s warranty. With the slice valves locked in the up position and the unions hand tightened, remove the floating weir, skimmer basket and filters from the filtration canister.

DO NOT FILL THE SPA WITH WELL WATER FROM A WATER SOFTENER. Do not use hot water when you fill your spa. When filling the spa, bypass the water softener system. If you must use well water to fill your spa, you should get professional assistance establishing base water quality that is safe your spa and for you. Well water often has higher mineral, metal and bacterial content that will damage the spa components and makes water chemistry maintenance difficult for novices. Because technical support is not familiar with your base water quality, they cannot help you achieve or maintain safe levels.

REMOVE THE FILTER ASSEMBLIES AND FILTERS. Lay the weir(s) and the filter basket(s) safely to the side. Place the filter(s) inside the foot well of the spa as the spa fills with water allowing filter(s) to saturate. Never install dry filters in your spa.

PLACE A GARDEN HOSE INTO THE EMPTY FILTRATION CANISTER AND TURN THE WATER ON. If you have more than one filter assembly, you should put the water hose in the one closest to the topside controls. Water fills the internal plumbing lines first, then you will see water flowing into the foot well and upward. Filling the spa this way fills the pumps and internal plumbing with lines with water,



reducing the risk of an air lock in the pumps(s) when power is applied. Continue filling the spa until the water level is approximately one inch over the highest jet, excluding jets that are designed for neck and shoulder massages. Under filling the spa prevents adequate flow through the water lines and pumps causing a potential air lock and damage to the pumps and heater. Damage that occurs because the spa is not filled properly or from improper water levels is not covered under the manufacturer's warranty.

REMOVE THE GARDEN HOSE AND TURN THE WATER OFF. Replace the filter, skimmer basket and floating weir. Check for leaks inside the spa cabinet, especially at the plumbing unions near pump(s) and heater. Hand tighten unions if necessary. If the spa is leaking and the unions are tight, DO NOT turn the GFCI on. Call a technical service associate at 844-894-6659 for assistance and repair before applying power to the spa.

TURN THE GFCI "ON"

When power is applied to the spa, the spa controls will immediately begin a self check cycle, which typically lasts 20 to 30 minutes. **DO NOT TOUCH THE TOPSIDE CONTROLS UNTIL THE LED DISPLAYS THE CURRENT WATER TEMPERATURE.** Pressing buttons on the topside controls before the LED displays the current water temperature will interrupt this cycle. Once the current water temperature is displayed on the LED, and following the instructions, it is safe to begin setting your preferences. Make sure water is circulating through all jets, that the diverter valves and air controls are functioning properly. Verify there are no leaks inside the spa cabinet. If the spa is functioning properly and there are no leaks inside the spa cabinet, reinstall the cabinet access panel.

RE-FILLING YOUR SPA WITH WATER

Follow these instructions step by step each time you re-fill the spa to ensure successful start up. Each time you fill your spa, it is a good idea to check the condition of the locks on the slice valves making sure they are intact and not damaged. At the same time you should check to be sure that all plumbing unions are hand tightened. Don't re-install the spa cabinet until the spa has been filled and power has been applied. The access panel should be replaced only after you have checked for leaks inside the spa cabinet with the pump(s) running and are sure all the pumps, jets, diverters and air valves are in proper working order.

If you need to replace the screws on the cabinet, use stainless steel screws which do not rust. If you would like to order screws that are painted to match your spa cabinet, please call a technical support representative at 844-894-6659 during normal business hours.



Providing Therapy for Life

For help, please call 844-894-6659

TOPSIDE CONTROLS

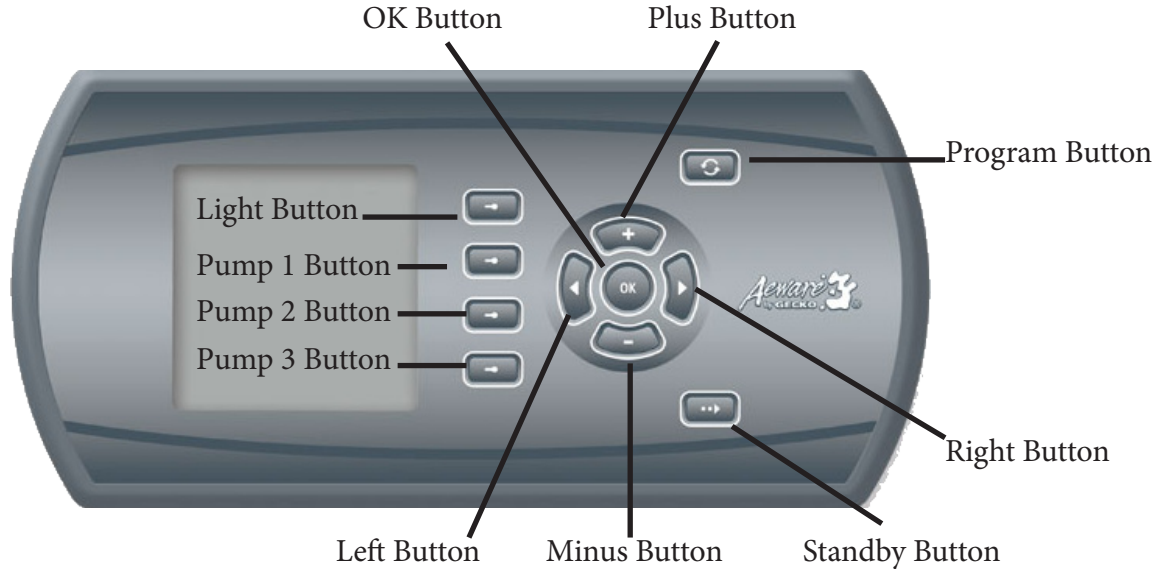

TOPSIDE CONTROL LED DISPLAY

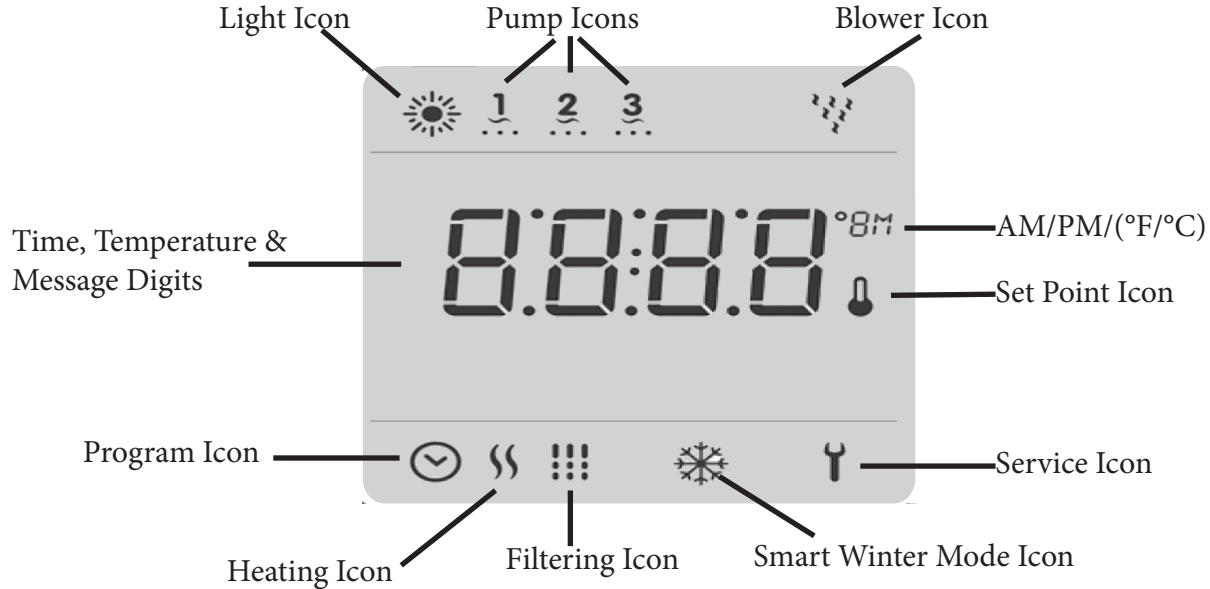

Providing Therapy for Life

For help, please call 844-894-6659



TOPSIDE CONTROL FUNCTIONS

On/Off Key



Depending on the spa model, this key may have one or a combination of the following functions: Standby, and /or On/Off and/or Economy Mode.

The first mode activates/deactivates with a short press of the key.

The second mode, if present, activates by pressing and holding for 3 to 6 seconds and deactivates with a short press on the key.

The third mode, if present, activates with a long press of 6 to 9 seconds and deactivates with a short press on the key.



On/Off Key

Sby

Depending on the spa model, this key may have one or a combination of the following functions: Standby, and /or On/Off and/or Economy Mode.

The first mode activates/deactivates with a short press of the key.

The second mode, if present, activates by pressing and holding for 3 to 6 seconds and deactivates with a short press on the key.

The third mode, if present, activates with a long press of 6 to 9 seconds and deactivates with a short press on the key.

Standby Mode:

OFF

This mode lets you stop all output and automatic functions except heating for 30 minutes. When active, the display will toggle between the “sby” message, the clock and the water temperature. To restart the system before the 30 minute delay ends, quickly press the On/Off key. The light will flash a few seconds to warn you the system is about to resume its normal operation. When the system resumes its normal operation, the display shows “On” for 30 seconds.

On/Off Mode:

Eco

This mode allows you to stop all output and automatic functions like the filter cycle, heat request and smart winter mode purge for 20 minutes to perform quick spa maintenance. When active, the display will toggle between the “OFF” message, the clock and the water temperature. To restart the system before the 20 minute delay ends, quickly press the On/Off key. The light will flash a few seconds to warn you the system is about to resume its normal operation. When the system resumes its normal operation the display shows “On” for 3 seconds.

Manual Economy Mode:

This mode allows energy conservation, keeping the water temperature 20°F (11°C) below the set point. When active, the display will toggle between the “Eco” message, the clock and water temperature. Quickly press the On/Off key to exit manual economy mode. When the system exits the economy mode the display shows “noE” for 3 seconds



Providing Therapy for Life

For help, please call 844-894-6659

Pump 1/Off Button



Pump 1

For spa models equipped with a dual-speed pump on pump 1, pressing this button once will turn pump 1 on low speed. Pressing a second time to turn pump to high speed. Press and hold the button for 5 seconds to turn the pump off. A built in timer automatically turns the pump off after 20 minutes unless pump has been manually deactivated first. If your spa model is equipped with a single speed pump, pressing this button will turn the pump on. If your spa model has a dual-speed pump, the indicator will flash when pump 1 is on low speed.

THE “PUMP 1” INDICATOR LIGHTS UP WHEN PUMP 1 IS ON.

Pump 2 Button



Pump 2

Press Pump 2 button to turn Pump 2 on low speed. Press a second time to engage high speed (if your spa model is equipped with a dual speed pump). Press and hold the button for 5 seconds to turn the pump off. A built in timer automatically turns the pump off after 20 minutes unless pump has been manually deactivated first. If your spa model is equipped with a single speed pump, press Pump button to turn the pump on. With dual speed pump, the indicator will flash when pump 2 is on at low speed.

THE “PUMP 2” INDICATOR LIGHTS UP WHEN PUMP 2 IS ON.

Pump 3 Button



Pump 3

Press Pump 3 button to turn Pump 3 on low speed. Press a second time to engage high speed (if your spa model is equipped with a dual speed pump). A third time turns the pump off. A built in timer automatically turns the pump off after 20 minutes unless pump has been manually deactivated first. If your spa model is equipped with a single speed pump, press Pump button to turn the pump on. Pressing the pump button again will turn the pump off. With dual speed pump, the indicator will flash when pump 3 is on at low speed.



THE "PUMP 3" INDICATOR LIGHTS UP WHEN PUMP 3 IS ON.

Light Button



Light

Press Light button to turn light on. A second press turns the light off. A built in timer automatically turns the light off after 20 minutes, unless blower has been manually deactivated first.

THE "LIGHT" INDICATOR LIGHTS UP WHEN LIGHT IS ON

Up/Down Buttons



Use Up or Down button to set desired water temperature. The temperature setting will be displayed for 2 seconds to confirm your new selection.

THE "SET POINT" ON THE DISPLAY SHOWS THE DESIRED TEMPERATURE, NOT THE CURRENT WATER TEMPERATURE!

PROGRAMMING MENU

You will set the clock, your preferences for filtration cycles, economy mode and temperature settings from the programming menu.

Light Button



Light

PRESS & HOLD THE LIGHT BUTTON FOR 5 SECONDS TO ACCESSES THE PROGRAMMING MENU. Use the Up or Down keys to adjust the parameters. Press and hold the light button for 5 seconds to jump to the next parameter.

THE CHANGES WILL BE SAVED AFTER CONFIRMATION OF THE LAST PARAMETER. IF NO KEY PRESSED FOR 10 SECONDS, THE SYSTEM WILL EXIT THE PROGRAMMING MENU WITHOUT SAVING THE CHANGES.



Providing Therapy for Life

For help, please call 844-894-6659

SETTING THE CLOCK

ENTER THE PROGRAMMING MENU BY HOLDING DOWN THE LIGHT BUTTON FOR 5 SECONDS. The display will show the current clock setting, the minutes will be solid and the hours will flash. Depending on the factory settings, your system may be set to a 24 hour military notation or standard 12 hour notation.

SETTING THE HOUR: Press the Up or Down button to adjust the hours (AM/PM). **PRESS AND HOLD THE LIGHT BUTTON FOR 5 SECONDS TO JUMP TO THE NEXT PARAMETER, THE MINUTES.**

SETTING THE MINUTES: Press the Up or Down button to adjust the minutes. **PRESS AND HOLD THE LIGHT BUTTON FOR 5 SECONDS TO JUMP TO THE NEXT PARAMETER, THE FILTER OR PURGE START TIME (FS).**

PROGRAMMING THE FILTRATION CYCLES:

A digital display showing the text "FS03" in a blue, segmented font. The "FS" is larger and more prominent than the "03".

The filter cycle menu consists of the programming the start time (FS), the duration (Fd) and the frequency (FF). A filter cycle starts all the pumps in high speed for one minute (purge step) then the pump will run in low speed for the remaining duration of the filter cycle (cleaning step).

Setting the filter cycle start time:

A digital display showing the text "FD03" in a blue, segmented font. The "FD" is larger and more prominent than the "03".

The display will show FSxx, "xx" representing the starting hour of the filter cycle. Use the Up or Down button to adjust the hours. **PRESS AND HOLD THE LIGHT BUTTON FOR 5 SECONDS TO JUMP TO THE NEXT PARAMETER, FILTER DURATION (Fd)**

In the example above, Filter Start was set to start at 3 O'clock

Setting the filter duration:

A digital display showing the text "FF03" in a blue, segmented font. The "FF" is larger and more prominent than the "03".

The display will show Fdxx, the "xx" representing the duration in hours of the filter cycle. Use the Up or Down button to adjust the duration. 0 = no filtration (not recommended); 24 = continuous filtration.

PRESS AND HOLD THE LIGHT BUTTON FOR 5 SECONDS TO JUMP TO THE NEXT PARAMETER, FILTER FREQUENCY (FF).

In the example above, Filter Start was set to last for 3 hours.



Setting filter cycle frequency:



The display will show FFxx, the “xx” representing the number of filter cycles per day. Use the Up or Down button to adjust the frequency. **PRESS AND HOLD THE LIGHT BUTTON FOR 5 SECONDS TO JUMP THE NEXT PARAMETER, ECONOMY MODE (EP).**

In the example above, the filtration cycles are set to run 3 times each day.

**THE “FILTER CYCLE” INDICATOR LIGHTS UP ON THE LED WHEN THE FILTER IS ON
THE “FILTER CYCLE” INDICATOR FLASHES ON THE LED WHEN FILTRATION IS SUSPENDED.**

SETTING ECONOMY MODE

Using Economy mode helps you conserve energy by allowing the water temperature to fall 20°F (11°C) below the set water temperature during of the day or night when the spa is not in use. The economy mode programming menu lets you establish the start time and the duration of the economy mode cycle.

Enabling Economy Mode

The display will show EP“x”, the “x” representing the state of the programmed economy (0=disable, 1=enable). Use the Up or Down

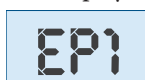

button to set the program economy to enable or disable. **PRESS AND HOLD THE LIGHT BUTTON FOR 5 SECONDS TO JUMP TO THE NEXT PARAMETER, ECONOMY START TIME (ES).**

In the example above, Economy Mode is enabled.

Setting economy start time:

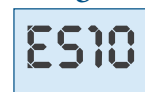

The display will show ESxx, the “xx” representing the hour economy mode will become active. Use the Up or Down button to adjust the hour. When the Economy mode is ON, the display will toggle between the “Eco” message and the water temperature. **PRESS AND HOLD THE LIGHT BUTTON FOR 5 SECONDS TO JUMP TO THE NEXT PARAMETER, ECONOMY DURATION (ED)**

In the example above, economy mode is set to start at 10.



Providing Therapy for Life

For help, please call 844-894-6659

Setting the economy duration:



The display will show Edxx, the “xx” representing the duration in hours of the economy mode. Use the Up or Down button to adjust the hour. 0= no economy. 24= continuous economy. **PRESS AND HOLD THE LIGHT BUTTON FOR 5 SECONDS TO JUMP TO THE NEXT PARAMETER, SETTING THE WATER TEMPERATURE.**

In the example above, the economy duration is set for 2 hours.

SETTING THE WATER TEMPERATURE

Water temperature can be displayed in either Fahrenheit (°F) or Celsius (°C). The display will show either F or C. Press the Up or Down key to change the setting. Use the Program Button or press “OK” to save all of the parameters

SMART WINTER MODE



Smart Winter Mode protects your system from cold by turning pumps on several times a day to circulate the water which prevents the water from freezing in pipes. The “Smart Winter Mode” indicator lights up on the LED when a freeze condition is detected and flashes while active.

COOL DOWN



After heating the spa water to the desired temperature, the heater turns off and the pump associated with the heater stays on low speed temporarily to ensure adequate cooling of the heating element. The heater icon flashes during this time.

WATER TEMPERATURE REGULATION

During a temperature regulation cycle, water flow is generated throughout the heater housing and plumbing to ensure accurate readings and avoid activation if there is no water in the system. After verifying pump activation and taking a water temperature readings, the system turns the heater on to reach and maintain the set water temperature. This icon will flash on the LED during temperature regulation cycles.



TROUBLESHOOTING ERROR CODES:

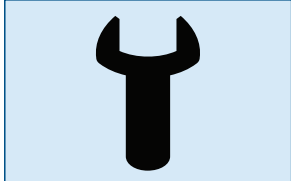

Should an error occur, the LED will display a wrench icon on the left of the screen and one of the following messages will toggle with the clock and the water temperature.

- **Hr:** An internal hardware error has been detected in the system. Call technical support at 844-894-6659.
- **HL:** The system has shut down because the temperature has reached 119°F (48°C). Do not enter the water! Remove the spa cover and allow the water to cool down, then manually power the GFCI “off” to allow the system to reset for 20 minutes, then manually power the GFCI “on”.
- **AOH:** Temperature inside the spa cabinet is too high, causing the internal temperature in the spa to increase above normal limits. Open cabinet and wait until the error clears.
- **FLO:** The system does not detect any water flow while the primary pump is running. Check and open the slice valves, suction drain covers and clean or replace the filter. If the problem persists, call technical support.
- **Prr:** A problem has been detected with the temperature probe. Call technical support at 844-894-6659.
- **OH:** The water temperature in the spa has reached 108°F (42°C). Do not enter the water! Remove the spa cover and allow the water to cool down to a lower temperature. If problem persists, call technical support at 844-894-6659.



Providing Therapy for Life

For help, please call 844-894-6659

THE IMPORTANCE OF GOOD WATER CHEMISTRY

For your health and safety, it is imperative to have clean, clear, water. Water maintenance will vary depending on many things like the base water quality, how often the spa is used and how many people use the spa. Remember, when it comes to water chemistry, filtration is not the same as sanitation. Following a regular schedule will help you achieve and maintain good water chemistry.

Bacteria and viruses grow quickly in water when it is not properly maintained. Maintaining your water is necessary not only for proper sanitation, but preventing buildup and deposits that will harm your spa.

One of the leading preventable causes of spa malfunction is failure to maintain good water chemistry. Too many chemicals may cause deterioration of the components, acrylic surface and the spa cover. Not enough sanitation allows impurities to accumulate, which will hinder performance and may cause permanent damage to the spa. Water can become unsanitary very quickly if chemicals are not used to adequately sanitize. Incorrect pH or calcium levels can lead to corrosion and scale build up on integral spa components.

The following guidelines have been established for swim spas by the Association of Pool and Spa Professionals:

pH	7.2 to 7.6
Free Chlorine	3.0 to 4.0 ppm
Free Bromine	2.0 to 4.0 ppm
Total Alkalinity	80 to 120 ppm
Calcium Hardness	150 to 250 ppm



COMMON SENSE WATER CHEMISTRY

Without chemicals, the warm water in your spa is the perfect environment for germs, bacteria and other living organisms. Chemicals added to your spa water are utilized as they destroy the bacteria from dead skin cells, sweat and other bodily fluids. Routine addition of sanitizers kept at constant levels keep your water clean and safe to use. Maintenance of proper water chemistry is different in every spa and for every spa user. Your water chemistry changes constantly. When the water in your spa evaporates, dissolved solids like calcium, salt and metal remain. They do not evaporate with the water. Adding more water adds more dissolved solids which may leave deposits on the acrylic surface and inside the spa components. When the cover is off, pollen, dust and dirt change the water chemistry. If you use your spa once a day, it will require more chemicals than the same spa used only once a week. What it takes to balance your water chemistry in January will be different in July.

THE MAJOR CONSIDERATIONS IN WATER CHEMISTRY ARE:

- The number of gallons of water in the spa
- The number of people using the spa
- The number of hours the spa is being used

In short, more water used by more people for longer periods means more chemicals. Whether you have used your spa or not, you should test your water twice a week. Regular testing lets you to make adjustments before your water chemistry is out of control. When it comes to chemicals, more is not better. Adding chemicals changes the pH. Fluctuations in the pH change the way chemicals react. The addition of too many chemicals may mean your only option is to drain the spa and start over. Depending on use and bather load, you should replace the water every four to six months to ensure your comfort and safety. Replacing the water will also help protect the spa components from damage caused by dissolved solids that build up over time.

OZONE GENERATORS

Your spa may have come with an ozone generator which will help reduce dissolved solids and increase oxygen in the water, but it will not sanitize the water without chemicals. You must use a sanitizer in tandem with the ozone generator. The ozone generator is designed to make chemicals more efficient and maintaining good water chemistry easier.



Providing Therapy for Life

For help, please call 844-894-6659

CHLORINE GENERATORS

Your spa may have come with an optional salt system, also known as a chlorine generator. This system is designed to maintain water chemistry by converting salt into sanitizer without using any chemicals. Since the system does not create any residual chlorine, water testing will not provide an accurate assessment of sanitation levels. Test strips are only used to test and maintain adequate levels of alkalinity, pH and water hardness when you have a chlorine generator.

Breaking Down the Basics

Each step of a water maintenance program is dependent upon the previous steps. Omission of any step or failing to reach the recommended ranges may cause an imbalance in water chemistry. Unbalanced water may cause damage to the spa components and create discomfort for bathers.

To measure the quality of your water, immerse a test strip in water following the instructions on the container. Do not touch the test strips as it may affect the results. Compare the test strip and the label to determine the condition of the spa water.

Step 1.) Balancing Total Alkalinity (TA)

The recommended total alkalinity levels are between 80 and 120 ppm. The Total Alkalinity is the measurement of carbonates, bicarbonates, hydroxides and other alkaline substances in the water. TA is referred to as the water's "pH buffer". It is a measure of the water's ability to resist changes in the pH level. If the TA is too low, the pH level will fluctuate quickly, easily and greatly. Changes in pH can cause corrosion or scaling on the spa components. You can correct low Total Alkalinity by adding sodium hydrogen carbonate (pH/Alkalinity Up).

Step 2.) Balancing Calcium Hardness (CH)

The recommended calcium hardness (CH) level for your spa is 150-250 ppm. Calcium Hardness is a measurement of the total amount of dissolved calcium in the water. Calcium helps control the corrosive nature of the spa's water. Calcium-low water (commonly known as "soft" water) is not recommended. It is highly corrosive to the components and can stain the acrylic surface.



IF THE CH IS TOO HIGH (COMMONLY KNOWN AS “HARD” WATER), formation of scale on the spa and the components can result. CH can be decreased by using a mixture of 75% “hard” water and 25% “soft” water; this will usually yield a reading of the correct range. If “soft” water is not available or practical for you, a stain and scale inhibitor should be added to the water according to the label instructions.

IF CH IS TOO LOW, add a CH increaser. Once the CH is balanced, it normally remains stable. Adding more water with a low or high calcium content should not raise or lower the CH reading of the water. When the Calcium Hardness is within recommended range, proceed to the next step.

Step 3.) Balancing the pH

The pH level is the measure of the acidity and the alkalinity. It is imperative to have a slightly alkaline pH level between 7.2 and 7.6. Problems become proportionately more severe the further outside this range the water gets. Values above 7 are alkaline; those below 7 are acidic. Maintaining proper pH level is extremely important for optimizing the effectiveness of sanitizer, maintaining water comfort for the users, and prevention of equipment deterioration.

IF THE pH LEVEL IN THE WATER IS TOO LOW, the sanitizer will dissipate rapidly, the water may become irritating to users, and the spa equipment may corrode. If the pH is too low, it can be increased by adding sodium hydrogen carbonate (pH/Alkalinity Up) to the spa water.

IF THE pH LEVEL IS TOO HIGH, the sanitizer is less effective, scale may form on the spa and the spa components, the water may become cloudy and pores in the filter cartridge will become clogged and obstructed. If the pH is too high, it can be decreased by adding sodium bisulfate (pH/Alkalinity Down) to the spa water.

Wait two hours after adding sodium hydrogen carbonate or sodium bisulfate before testing the pH levels again. It is important to check the pH level on a weekly basis. The pH will be affected by the bather load, the addition of new water, the addition of chemicals and the type of sanitizer used. When the pH is within the recommended range, proceed to the final step.



Providing Therapy for Life

For help, please call 844-894-6659

STEP 4.) MAINTAINING THE SANITIZER LEVELS

Sanitizer is extremely important. It kills algae, bacteria and viruses while preventing unwanted organisms from growing in the spa. At the same time, if the sanitizer levels are too high it may cause irritation to the skin, lungs and eyes. Always maintain the sanitizer level in your spa at the recommended levels specified for each type of sanitizer. You should check the your sanitizer and pH levels before each use and at least twice each week even if the spa is not in use.

NEVER PRE MIX DRY CHEMICALS

ALWAYS FOLLOW INSTRUCTIONS ON THE LABEL

HIGH LEVELS OF SANITIZER CAN CAUSE DISCOMFORT TO EYES, LUNGS AND SKIN.

NEVER ENTER THE SPA IF CHEMICAL LEVELS EXCEED THE RECOMMENDATIONS.

Adding Chemicals

The water temperature must be at least 80°F before adding chemicals to prevent damage to the acrylic surface. Always wear safety goggles and gloves to prevent injury. Remove the cover. Fill a large bucket (minimum 2 gallon capacity)with warm water from the spa. Use care not to splash chemicals onto the spa cabinet, or the acrylic surface of the spa. Carefully measure the recommended amount of each chemical, one at a time, following the instructions on the label. Replace the lid on the chemical container.

Thoroughly mix the chemical with the bucket of warm water from the spa. Remove the filter basket assembly and filter. Press the Primary Pump button to turn the pump on high speed. With the pump running on high speed, being careful not to get too close, add warm water and chemical mixture into the filtration canister. Repeat this procedure with each chemical you add. When all chemicals have been added and with the cover off the spa, run the pumps on high speed for ten minutes. After 10 minutes, reduce the pump speed to low for one full cycle. When the jet cycle is complete, replace the filter and the filter assembly. Replace and lock the cover. Never leave the spa unattended when the cover is off.

Do not use tri-chlor chlorine, bromo-chlor-dimethyl-hydantoin (BCDMH) or any type of compressed bromine or chlorine, acid or any sanitizer not recommended Dr. Wellness Swim Spa.



Using the Drain Bib to Empty your Spa

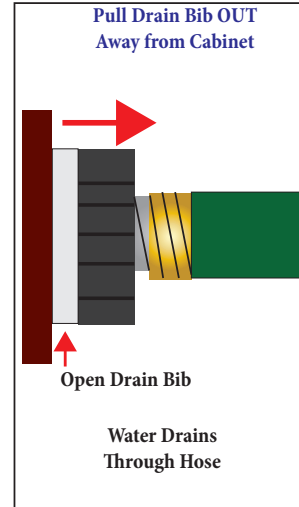
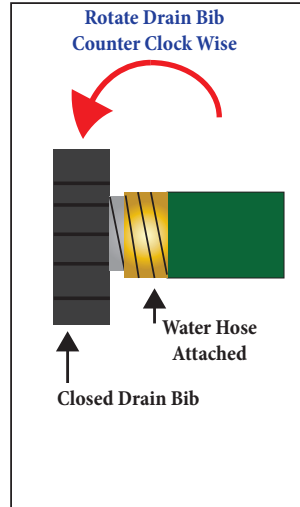
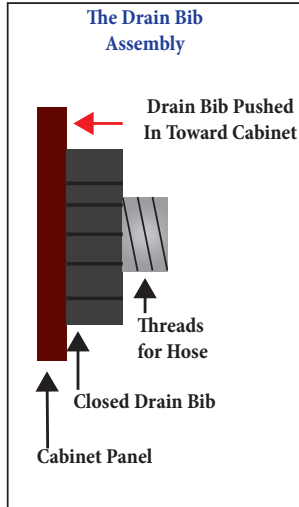

Using a submersible sump pump makes draining easier and faster.
Using the drain bib may not be practical because of the water capacity.

DISPOSING OF WATER

Because heavily treated water may be harmful to the environment and because some areas are prone to flooding, some communities regulate or restrict the disposal of the water from your spa. Typically, if the pH & chemical levels are correct, you can drain the water on your own lawn provided there is no potential of erosion or flooding to surrounding properties or storm drains.

Check with local officials before you drain your spa.



Providing Therapy for Life

For help, please call 844-894-6659

HEAVY CLEANING OR DECONTAMINATION

On occasion, it may be necessary to “Super Sanitize” your spa. If algae develops, simply replacing the filter, draining and refilling the spa will not kill the algae. It will be necessary for you to decontaminate the spa before it can be used safely.

WARNING!

**DURING THE DECONTAMINATION PROCESS, EXCESSIVE CHEMICAL VAPORS ARE PRODUCED.
WEAR GLOVES AND A PROTECTIVE MASK DURING THE DECONTAMINATION PROCESS.
KEEP CHILDREN AND PETS AWAY FROM THE SPA.**

REMOVE THE SPA COVER, ALL PILLOWS AND COVER THE PLASTIC VALVES TO PROTECT THEM.

IF YOUR SPA IS INDOORS, OPEN THE WINDOWS AND DOORS. USE A FAN TO CIRCULATE THE AIR AND FORCE THE VAPORS OUT OF THE ROOM.

REMOVE THE FILTER BASKET ASSEMBLY, FILTER AND SPA PILLOWS. Before adding chemicals, make sure all pumps are operable. Check to be sure all jets and air valves are open. Be certain the diverter valves covered to protect them from splashes and are in the center position allowing even circulation throughout the entire spa.

TURN ALL PUMPS ON LOW SPEED. In a large bucket (minimum 2 gallon capacity) filled with warm water, carefully add 2.5 ounces of sodium dichlor for every 100 gallons of water in the spa and mix thoroughly in the bucket. For example, if there are 400 gallons of water in your spa, add 10 ounces of sodium dichlor to the large bucket filled with warm water. Turn all of the pumps on low speed. Gently pour the warm water and chemical mixture into the filter housing. After all of the sodium dichlor mixture has been added, turn all pumps on their highest speed and allow the water to circulate for one hour. Do not replace the cover over the spa during decontamination. Never leave the spa unattended while it is uncovered.

AFTER THE SPA HAS BEEN ALLOWED TO RUN FOR ONE HOUR, turn off all of the pumps and manually turn the GFCI “off”. Drain the spa. Follow the steps to fill the spa and remember to put a new filter in the foot well of the spa allowing it to saturate as the spa fills with water. Add chemicals as needed to maintain proper water chemistry.



Filter Care and Replacement

The filter catches debris that is too small for the filter basket, like hair, lotion and body oil. A dirty filter means dirty water. Filters are made of compressed fibers that decompress over time. After the fibers break down and become saturated with dirt and oil allowing contaminants and debris to enter the spa, causing unnecessary strain on the pumps and damaging the components. You should have to have a supply of replacement filters on hand, in addition to chemicals used to maintain your water. Extra filters are affordable, can be delivered to your home and purchased at www.dr-wellness.com

YOUR FILTER NEEDS TO BE CLEANED OR REPLACED WHEN:

- You notice reduced flow from the jets
- The water is hazy, cloudy or discolored
- The heater is running more frequently but the water is not heating evenly or normally

CLEANING YOUR FILTER

Your filters should be cleaned every two to four weeks, depending on use. Manually turn the GFCI “off”. Following the steps to remove the filter assembly, remove the filter. With a garden hose equipped with a high pressure spray nozzle, rinse the filter making sure to spray between each pleat.

DEEP CLEANING YOUR FILTER

Filter cleaners may help remove some collected dirt, lotion and body oils that rinsing won't remove. Following the instructions on the bottle of filter cleaner, carefully place the filter in the cleaning solution. Let the filter soak in the solution following the instructions on the cleaner label. Remove the filter and thoroughly rinse making sure to spray between each pleat. Allow the filter to dry completely. When the filter is dry, brush between each pleat with a fine hair brush. After brushing between the pleats, place the filter in a bucket filled with water or in the spa until the filter is saturated. Replace the filter and reassemble the filter assembly.

NEVER USE A WIRE BRUSH ON THE FILTER.

NEVER PUT YOUR FILTER IN THE DISHWASHER.

NEVER PUT A DRY FILTER IN THE FILTER HOUSING.



Providing Therapy for Life

For help, please call 844-894-6659

REPLACEMENT FILTER CARTRIDGES

Deep cleaning dirty filters is time consuming, requires the use of additional chemicals and may not remove all residual dirt, body oil and bacteria if not done properly. Depending on use and bather load, Dr. Wellness recommends that you replace your filters every 3 months.

ALWAYS

Wash your hands after handling chemicals. In case of accidental contact, follow the emergency advice on the product label. If a doctor is needed, take chemical containers with you to the hospital so the substances can be identified.

Clean up spilled chemicals immediately using water from a water hose. Saturate the surrounding area thoroughly, especially areas used by children and pets to ensure safety.

Keep chemicals in their original container with the lid replaced properly after using. Keep containers closed when not in use.

Keep chemicals away from children and pets. Allow a responsible person to handle spa chemicals; use care when handling chemicals.

Store chemicals in a cool, dry, well ventilated place.

Follow local laws when disposing of the water in your spa.

NEVER

Allow the water drained from your spa to run into public water sources.

Add chemicals when the water temperature is below 80°F

Smoke when adding chemicals. Some of the chemicals are highly flammable and smoking can lead to serious injury.

Store chemicals in the spa cabinet or expose to extreme temperatures or bright light.

Allow anyone in the spa while adding chemicals. Inhaling fumes or contact with your eyes, nose or mouth is very dangerous.

Use swimming pool chemicals, muriatic acid or household bleach, or chlorine tablets (trichlor) in your spa. It can be extremely corrosive. Damage caused by use of tri-chlor is not covered under the manufacturer's warranty.

Use a vacuum cleaner to clean up chemical spills or allow spilled chemicals to get on surrounding surfaces or landscaping.



CARE AND MAINTENANCE

Your Dr. Wellness spa was manufactured with the highest quality of materials and care available in the spa industry making sure you spend more time enjoying your spa than you do taking care of it. Just as a healthy body requires an occasional check up, a healthy spa requires some maintenance and attention. Developing a regular routine of care ensures your spa's health and your peace of mind.

CARING FOR THE ACRYLIC SURFACE

Your spa was cast from Lucite® Acrylic making it durable and resilient. It is dirt and stain resistant. Using household cleaners and detergent may leave a dulling residue. When needed, wipe the surface with warm water and a soft cloth. Never use abrasive, ammonia or citrus based cleaners because they will damage the acrylic. Chemicals in some cleaners may have react negatively with the chemicals used to maintain water chemistry.

CARING FOR THE CABINET PANELS

Your spa cabinet is water and weather resistant. It is virtually maintenance free. You will never need to wax, paint or seal the cabinet. When necessary, rinse the cabinet with water from a water hose equipped with a moderate pressure nozzle. More stubborn dirt can be removed by rubbing with a damp, soft cloth. Never use abrasive cleaners or a high pressure hose which may scar the cabinet.

CARING FOR THE PILLOWS

The pillows in your spa are covered in water resistant vinyl. To prevent discoloration, they should be wiped off periodically to remove chemical residue and treated with a non-alcohol based vinyl protector. Many vinyl protectors are oil based and should be avoided. Using oil based products will adversely affect water clarity and chemistry which can be difficult to correct. If you are not using your spa for a prolonged period, pillows should be removed from the spa, dried off and stored. If the vinyl is punctured and the foam is exposed they should be replaced. *Replacement pillows are available. Please call a technical support representative at 844-894-6659.*

CARING FOR THE JETS

Most of the jets are interchangeable with other jets that are the same size and can be turned on and off by rotating the outside of the jet. It's a good idea to leave all of the jets open to prevent damage that can occur when excessive pressure builds in the plumbing lines. When jets become difficult to rotate, they should be cleaned. With the GFCI in the "off" position, rotate each jet counter clockwise



Providing Therapy for Life

For help, please call 844-894-6659

until it reaches its built in “stop” and gently pull the jet outward, removing it from the jet housing. Place all of the jets in a bucket filled with white vinegar overnight. Rinse with warm water. Stubborn dirt on the white part of the jet body can be removed with a soft bristle brush. Do not use steel wool or a wire brush. You should clean your jets each time you drain your spa. If the white jet body on the back of the jet is damaged it should be replaced. *Replacement jets are available by calling a technical support representative at 844-894-6659.*

CARING FOR THE LIGHTS

The lense cover over the underwater light is permanently installed. Do no attempt to remove the lense cover. When the spa has been drained, wipe the light lense with a cloth designed for cleaning eyewear to prevent scratching the lense cover. If the other side of the large underwater light is also dirty, remove the cabinet panel, remove the bulb from the lamp holder and wipe with a cleaner and cloth designed for cleaning eyewear. Replace the bulb. Make sure the bulb was properly replaced and the light works before reinstalling the cabinet panel. *If you need a replacement bulb, please call a technical support representative at 844-894-6659.*

DO NOT ATTEMPT TO CLEAN THE BACK SIDES OF THE PERIMETER LIGHTING LENSE COVERS.

CARING FOR AUDIO/VIDEO SYSTEMS

If your spa is equipped with an audio or video system, you will hear your selection from the built in speakers. You should wipe chemical residue from the speaker covers with a soft cloth to prevent discoloration. The sub-woofer is enclosed in the spa cabinet and does not require routine maintenance. The built in audio/video components and docking station compartment should be cleaned with a soft, dry cloth. While you are outside the spa, place your selection in the player, push play, and select the volume from the device. Before you enter the spa, plug in your MP3 player and place it in the docking station. Close the docking station door for your safety and to protect your device.

NEVER PLACE YOUR MP3 PLAYER OR OTHER ELECTRONIC DEVICES ON THE SIDE OF THE SPA.

NEVER HANDLE AUDIO/VIDEO DEVICES WHILE INSIDE THE SPA.

NEVER USE HEADPHONES IN THE SPA.



CARING FOR THE SPA COVER

The foam cores in your spa cover are designed to protect your spa from the elements, reduce heat loss, keep unwanted debris out of the spa, and to prevent evaporation. You should clean the vinyl with a small amount of mild dish soap diluted in warm water and a soft sponge 3 or 4 times a year. Allow to dry and wipe with an oil free, non-alcohol based vinyl protector. Many vinyl protectors are oil based and should be avoided. Using oil based products will adversely affect water clarity and chemistry which can be difficult to correct. Using alcohol or chlorine based cleaning products will cause the stitching to deteriorate and damage the UV inhibitors built into the vinyl. The locking tie downs are not designed to keep the cover in place in heavy winds. You should consider using wind straps to stabilize the cover and protect the spa. Use the handles to remove and replace the cover. The cover is sturdy but should never be dragged and is not designed to hold heavy weight loads. Heavy snow loads should be brushed off with a clean soft bristle broom. Never stand on or allow children or pets on the spa cover. When the spa is not in use, the cover should be in place with the tie downs.

CARING FOR THE SPA IN COLD WEATHER

Your spa is well insulated to make it economical to operate even in the coldest climate. As long as it is filled with water and power is supplied, the spa will function in January just as it did in July. Keeping your spa fully operational at all times is the best protection. We do not recommend draining your spa and disconnecting the power supply in the winter. If you live in an extremely cold climate or an area where power outages are common and the spa is subjected to freezing temperatures, we encourage you to hire a professional to winterize your spa safely. The standard of practice varies by location. All of the water must be removed from the filter housing, pumps, heater, jets and plumbing lines. Simply draining the water as you would for normal maintenance will not provide adequate protection from freezing. Damage that occurs if the spa freezes is not covered under the warranty.

If you experience system failure and the spa is exposed to freezing temperatures, manually turn the GFCI “off” for 30 minutes then turn the GFCI “on”. The system may reset and function normally. If that fails, call a technical support representative immediately at 844-894-6659. If the system failure occurs after hours, and your pumps will not circulate the water, you should place a low wattage space heater inside the cabinet near the spa equipment to help prevent freezing. To avoid the risk of fire or injury, do not leave the spa unattended when the heater is inside the cabinet. If you leave home, turn the heater off.



Providing Therapy for Life

For help, please call 844-894-6659

TROUBLESHOOTING WATER CHEMISTRY

Problem	Could be Caused By	Could be Solved By
Water Will Not Balance	Well, Untreated Municipal or Softened Water	<i>SEEK LOCAL PROFESSIONAL ASSISTANCE.</i> The manufacturer does not recommend filling the spa with well, untreated or softened water.
Cloudy Water	Dirty Filter Excessive Organic Matter Bacteria on Cover Dripping into Spa Improper Sanitization Suspended Organic Matter End of Water Life	Replace Filter Add Shock Clean Cover with Approved Cleaner Add Sanitizer Clean or Replace Filter, Add Shock, Run Jets Drain & Refill Spa, Replace Filter
Green or Brown Water	Excessive Metal	Add Metal Sequestering Agent
Excessive Foam	Accumulation of oil, cosmetics and detergent	Add Defoamer Clean or replace filter Run extra rinse cycle when washing swim wear
Water has Bad Smell	Excessive Organic Matter - Bacteria Growth Improperly Sanitized Low pH	Add Shock Add Sanitizer Adjust pH



TROUBLESHOOTING WATER CHEMISTRY

Problem	Could be Caused By	Could be Solved By
Smells Musty	Bacteria Growth	Add Shock. If the problem persists, perform Spa Decontamination
Ring Around Spa	Build Up of Oil & Dirt	Wipe surface with cloth, drain and refill spa.
Algae	High pH Low Sanitizer Level	Add pH Reducer Add Shock & Sanitizer
Eye or Skin Irritation and/or Rash	Improper Sanitation Free Chlorine too High Dirty Filter	Test Water. Add Shock & Sanitizer as Needed Add Water Causing Sanitizer Levels to Drop Clean or Replace Filter
Stains on Acrylic Surface	High Alkalinity or Low pH High Mineral Content High Metal Content	Adjust Alkalinity and pH Accordingly Use Stain & Scale Reducer Use Metal Sequestering Agent
Scale Build Up	High Calcium Levels	Adjust Alkalinity; Use Stain & Scale Reducer



Providing Therapy for Life

For help, please call 844-894-6659

SPA TROUBLESHOOTING GUIDE

THE FIRST STEP IN THE TROUBLESHOOTING PROCESS IS TO CHECK THE TOPSIDE CONTROLS FOR DIAGNOSTIC MESSAGES.

If you do not see the solution to your problem , please call a technical support associate at 844-894-6659 for assistance.

WHEN MAKING REPAIRS TO YOUR SPA, YOU SHOULD ALWAYS MANUALLY TURN THE GFCI “OFF” TO ELIMINATE RISK OF SHOCK.

Problem	May be Caused By	Might Be Solved By
LED Display is blank	Power is off or fuse is blown	Reset GFCI and Main Service. Replace blown fuses
Spa Will Not Power Off	Spa is heating Spa is filtering	Lower temperature settings Normal function of spa
Spa Leaking	Loose unions	Hand tighten unions
GFCI Tripping	Improper wiring	Get Electrician to check neutral wiring connections at GFCI
Pump(s) Not Working	Air Lock Pump Cycle has ended Slice Valves Closed No Power Blockage in line	Bleed the pump(s) Press button to turn pump on Open Slice Valves Check pump connection in spa control box Clear obstructions in filter assemblies
Pump(s) run hot	Pump running dry Flow restricted	Call technical support at 844-894-6659 Remove debris from filter basket and suction valves.
Pump Surges	Water level too low Blockage or restriction	Add water Empty filter basket and clean suction drain covers



SPA TROUBLESHOOTING GUIDE

THE FIRST STEP IN THE TROUBLESHOOTING PROCESS IS TO CHECK THE TOPSIDE CONTROLS FOR DIAGNOSTIC MESSAGES.

If you do not see the solution to your problem , please call a technical support associate at 844-894-6659 for assistance.

WHEN MAKING REPAIRS TO YOUR SPA, YOU SHOULD ALWAYS MANUALLY TURN THE GFCI “OFF” TO ELIMINATE RISK OF SHOCK.

Problem	May be Caused By	Might Be Solved By
No or Low Heat	Spa is at correct temperature Operating Mode Temperature Setting Breaker(s) off Dirty Filter Air Lock or Closed Slice Valve Improper Line Voltage	Normal function of spa Check to be sure the spa is not in Economy Mode Check LED display to see if Heater Icon is illuminated Reset GFCI and Main Breaker Change filter Make sure slice valves are open and pumps are not air locked Have an electrician check voltage
Heats, but not High Enough	Thermostat turned down Dirty filter Slice valve closed Spa cover shifted	Increase temperature setting Change filter Open slice valves Reposition spa cover
Over Heat Message on LED	Filtration settings Outside temperature high to allow cooling	Reduce number and duration of filtration cycles Temporarily remove cover and/or add cold water



Providing Therapy for Life

For help, please call 844-894-6659

Manufacturer's Limited Warranty

Spa Warranty Policies and Procedures

Important Notice: The following are not actual warranties, but detailed descriptions of our warranty policies and procedures. Certain exclusions and disclaimers may apply to these descriptions. Be sure you read and understand the spa warranty. These policies and procedures are subject to change at any time and without notice. Throughout this document, Dr. Wellness Spas shall be referred to as the "MANUFACTURER". Each spa warranty is given to the original consumer only and terminates upon transfer of ownership. Any commercial applications are excluded from all warranties.

Labor Warranty

Labor is described as the work completed by a technician. MANUFACTURER will be responsible for the costs associated for labor for all warranty repairs for six (6) months from the original date of purchase. THIS WARRANTY IS GIVEN TO THE ORIGINAL CONSUMER AND TERMINATES UPON TRANSFER OF OWNERSHIP. COMMERCIAL APPLICATIONS ARE EXCLUDED FROM THIS WARRANTY. It is the responsibility of the spa owner to ensure that the spa is accessible for repairs. MANUFACTURER is not responsible for any cost associated with making spa accessible for repairs. If parts are required for repair, MANUFACTURER is not responsible for the cost of shipping of parts under the terms of this warranty agreement.

Warranty Procedures

THE DR. WELLNESS SPAS WILL WORK WITH YOUR DEALER TOWARD RESOLVING YOUR WARRANTY REQUEST AS QUICKLY AS POSSIBLE. TO ENSURE THE EFFICIENT PROCESSING OF YOUR WARRANTY CLAIM, PLEASE FOLLOW THESE STEPS:

1. The MANUFACTURER relies upon the consumer and service technician to assist in warranty claims and how best to work toward the consumer's satisfaction. If you have any questions concerning a claim, you should call your local dealer for assistance.
2. If the claim is determined to be valid you will need to submit to Dr. Wellness Spas the proof of purchase, photographs of the spa, wiring configurations, components and the surrounding area where the spa is supported. Dr. Wellness Spas will determine the proper solution for repairing the spa. Warranty requests must include the following information:

* Spa Model
* Date of Delivery
* Dealer Name

* Name & Address of Customer* Spa Serial Number
* Date of Purchase
* Photographs of the area of concern

* Phone number of Customer
* Date of Installation
*Thorough Description Problem

MOST OF THIS INFORMATION IS ON THE ORIGINAL PURCHASE INVOICE.



Manufacturer's Limited Warranty

3. Upon receipt of all of the requested information, Dr. Wellness Spas will evaluate it and decide how the claim will be resolved. Repair or replacement is at the MANUFACTURER'S discretion. In all situations, a repair is considered the appropriate course of action. If the spa cannot be repaired in the field and must be returned to the factory, approval must be obtained from Dr. Wellness Spas. Cost for removal of the defective spa, delivery and installation of the replacement spa are the responsibility of the consumer and will not under any circumstances be covered by the MANUFACTURER. It is the responsibility of the spa owner to ensure that the spa is accessible for repairs. MANUFACTURER is not responsible for any cost associated with making spa accessible for repairs. If parts are required for repair, MANUFACTURER is not responsible for the cost of shipping of parts under the terms of this warranty agreement.

4. Partial documentation submissions will not be considered and do not constitute filing a warranty claim. MANUFACTURER is not responsible for delays caused by failure to submit all of the information in a timely manner.

Surface Warranty

The spa surface is defined as the exposed material finish. The MANUFACTURER warrants the spa surface to be free from defects in material and workmanship, such as blistering, cracking, or delamination, under normal use and maintenance for a period of five (5) years from the original date of purchase.

The spa must be placed on a level concrete slab sufficiently engineered to support the entire length and width of the spa when filled to capacity. Standard building practices must be followed. Damage caused by failure to have a properly leveled and supported foundation under the spa is not covered under warranty. The MANUFACTURER does not warrant against problems associated with prolonged standing water, prolonged exposure to sunlight and/or use of any sanitation or ozone system not approved by the MANUFACTURER.

Damage to the spa surface caused by leaving the spa uncovered and/or empty of water with direct exposure to sunlight will terminate this warranty. Any alteration to any system, including but not limited to electrical, plumbing, or mechanical, improper water chemistry, or any other problems caused by any external source are not covered under warranty. Other exclusions may apply.

Normally, problems associated with material and workmanship can and will be repaired. If the spa surface is repaired, the repair is limited to the affected area only, and there is no guarantee against discoloration or fading. The decision to repair will be made by the MANUFACTURER and its field representative after review of the facts, pictures, or any other data presented by the dealer or the customer. In all cases, pictures of the affected area and foundation of the spa must be provided before any decisions to repair or replace will be made. In the unlikely event a spa is replaced, all warranties (including but not limited to shell, acrylic, equipment and plumbing) date back to the original date of purchase. If it is determined that the shell is to be replaced, the same conditions and terms as outlined in the shell warranty section apply. It is the responsibility of the spa owner to ensure



Providing Therapy for Life

For help, please call 844-894-6659

Manufacturer's Limited Warranty

that the spa is accessible for repairs. MANUFACTURER is not responsible for any cost associated with making spa accessible for repairs. If parts are required for repair, MANUFACTURER is not responsible for the cost of shipping of parts under the terms of this warranty agreement.

Structural Frame Support Warranty

The spa structure and frame are defined as the exposed material finish. The MANUFACTURER warrants the framing structural support to be free from defects in material and workmanship under normal use and maintenance for the lifetime of the spa, not to exceed a period of seven (7) years from the original date of purchase.

Damages to the spa structure and frame, including but not limited to dry rot that occurs as the result of failure to reinstall or replace damaged cabinet, wet rot that is occurs as the result of prolonged exposure to standing water, damage that occurs as the result of relocation after initial installation, insect or rodent damage, neglect, misuse, abuse, improper care or maintenance, or Act of God will not be covered under this warranty. This is not an all inclusive list. The spa must be placed on a level concrete slab sufficiently engineered to support the entire length and width of the spa when filled to capacity. Standard building practices must be followed. Damage caused by failure to have a properly leveled and supported foundation under the spa is not covered under warranty. Any alteration or any other problems caused by any external source are not covered under warranty.

Normally, problems associated with material and workmanship can and will be repaired. If the spa structure and frame are repaired, the repair is limited to the affected area only. The decision to repair will be made by the MANUFACTURER and its field representative after review of the facts, pictures, or any other data presented by the dealer or the customer. In all cases, pictures of the affected area and foundation of the spa must be provided before any decisions to repair or replace will be made. In the unlikely event a spa is replaced, all warranties (including but not limited to shell, acrylic, equipment and plumbing) date back to the original date of purchase. If it is determined that the structural frame is to be replaced, the same conditions and terms as outlined in the structural frame warranty section apply. It is the responsibility of the spa owner to ensure that the spa is accessible for repairs. MANUFACTURER is not responsible for any cost associated with making spa accessible for repairs. If parts are required for repair, MANUFACTURER is not responsible for the cost of shipping of parts under the terms of this warranty agreement.

Components Warranty

The components may be defined as the electrical items (i.e, pumps, equipment packs, heaters, topside, etc.) The MANUFACTURER warrants all components to be free from defect in material and workmanship for five (5) years. This is a full warranty for the first two (2) years and shall be



Manufacturer's Limited Warranty

prorated for the remaining period with the original owner responsible for the following percentages of the replacement or repair: 50% for year 3, 65% for year 4, and 80% for year 5. THIS WARRANTY IS GIVEN TO THE ORIGINAL CONSUMER ONLY AND TERMINATES UPON TRANSFER OF OWNERSHIP. COMMERCIAL APPLICATIONS ARE EXCLUDED FROM THIS WARRANTY.

Some components including, but not limited to, the spa cover, ozonator, salt system, jet faces, skirting, and pillows are warranted to be free from defects in materials and workmanship for one (1) year. Audio and video components, speakers and related parts, are warranted to be free from defects in materials and workmanship for ninety (90) days. Some items, including, but not limited to pump seals are a maintenance item and are covered for manufacturing defects only. Damage caused by weather, poor water chemistry, standing water and/or improper maintenance will not be covered under this warranty. Alterations or replacement of components installed in the spa that are not purchased and/or approved by the MANUFACTURER will terminate the spa warranty.

It is the responsibility of the spa owner to ensure that the spa is accessible for repairs. MANUFACTURER is not responsible for any cost associated with making spa accessible for repairs. If parts are required for repair, MANUFACTURER is not responsible for the cost of shipping of parts under the terms of this warranty agreement.

Plumbing Warranty

The plumbing may include all piping, jets and valves. The MANUFACTURER warrants all plumbing parts to be free from defect in material and workmanship for five (5) years. This is a full warranty for the first two (2) years and shall be prorated for the remaining period with the original owner responsible for the following percentages of the replacement or repair: 50% for year 3, 65% for year 4 and 80% for year 5. THIS WARRANTY IS GIVEN TO THE ORIGINAL CONSUMER ONLY AND TERMINATES UPON TRANSFER OF OWNERSHIP. COMMERCIAL APPLICATIONS ARE EXCLUDED FROM THIS WARRANTY. Jet internals, valve and diverter handles are not covered under this warranty. Damage caused by weather, poor water chemistry, standing water, and/or improper maintenance will not be covered under this warranty. It is the responsibility of the spa owner to insure that the spa is accessible for repairs. MANUFACTURER is not responsible for any cost associated with making spa accessible for repairs. If parts are required for repair, MANUFACTURER is not responsible for the cost of shipping of parts under the terms of this warranty agreement.

Components and Plumbing Warranty Procedures

DR. WELLNESS SPAS AND YOUR LOCAL DEALER WILL WORK WITH YOU TO MAKE THE PROCESS AS EASY AS POSSIBLE. TO ENSURE FAST & EFFICIENT PROCESSING OF COMPONENTS AND PLUMBING CLAIMS, PLEASE FOLLOW THESE STEPS:

1. Your local dealer & Dr. Wellness Spas must determine whether or not damage is due to manufacturer's defect. If the damage is due to manufacturer's



Providing Therapy for Life

For help, please call 844-894-6659

Manufacturer's Limited Warranty

defect, the MANUFACTURER will warrant the defective part during the warranty period. This does not include any travel or trip charges, troubleshooting or diagnostic charges. Customers living outside the technician's travel area need to be aware that trip charges are their responsibility.

2. Dr. Wellness Spas will troubleshoot the problem and supply necessary parts for repair. The authorized technician will repair the problem. If the technician has a problem with a service call, your dealer should call Dr. Wellness Spas for assistance. Upon satisfactory completion of warranty repairs, a Satisfaction of Service (SOS) form should be completely filled out by the service technician and signed by the customer.

NOTE: THE SPA SERIAL NUMBER SHOULD BE TAKEN DIRECTLY OFF THE SPA SO THE CORRECT WARRANTY IS APPLIED.

3. Upon request, the defective parts must be returned. Dr. Wellness Spas will process the warranty claim(s) within fifteen (15) working days (if claim is received in the proper time frame and all required information is submitted with the claim). Claims turned in late or without the proper documentation will be delayed. It is the responsibility of the spa owner to ensure that the spa is accessible for repairs. MANUFACTURER is not responsible for any cost associated with making spa accessible for repairs. If parts are required for repair, MANUFACTURER is not responsible for the cost of shipping of parts under the terms of this warranty agreement.

Items Not Covered Under the Warranty

The following is a general overview of non-warranty items and work. This is NOT an all-inclusive list.

- | | | | | | |
|-------------------------|-----------------------|---|------------------|------------------------------|---------|
| * Shipping Charges | * Diagnostic Services | * Fuses | * Valve Handles | * Light bulbs of any kind | * Seals |
| * Filters | * Acts of Nature | * Wear and Tear | * Travel Charges | * Filling | |
| * Chemical misuse | * Draining | * Damage caused by improper installation | | * Removal and/or Replacement | |
| * Making Spa Accessible | | * Any part not purchased from Dr. Wellness Spas | | | |

The fuses, cabinet finish, and filters are warranted to be free of defects in workmanship and materials at the time of delivery. Any alterations that have not been PRE-APPROVED by the MANUFACTURER will void all warranties. If an alteration is approved by the MANUFACTURER, it is the consumer's responsibility to verify that the alteration is covered under warranty. Not all every service request is considered a warranty call. For example, moving the tub to access the problem is not considered a warranty call.

The MANUFACTURER understands that some problems take longer than the allowed time to correct. An authorization number will be required to extend warranty coverage for service calls requiring additional time. If you need re-authorization from the MANUFACTURER, a detailed description must be included with the warranty claim for approval.



Manufacturer's Limited Warranty

Limitations

The Dr. Wellness Spas warranty is terminated if the spa has been subject to alteration, misuse, or abuse. Misuse or abuse is defined as but not limited to: use of spa in non-residential situations, water temperatures outside the ranges of 32 to 110 degrees, damage caused by clogged or dirty filters, damage caused by the absence of a hard cover, damage caused by failure to adequately maintain water chemistry, use of any type of acid, water left standing, or chemical imbalance. The spa owner is required to provide adequate access to the spa for any repairs or inspections. This warranty is terminated if any extra components area installed without the MANUFACTURER'S prior approval and consent or if any repairs have been attempted or made by anyone who has not received prior authorization from Dr. Wellness Spas.

Disclaimer

Your sole and exclusive remedy and the Manufacturer's entire liability, if any, is limited to repair or replacement of the defective part, at the manufacturer's discretion, in accordance with the terms of this limited warranty. There are no additional warranties, express or implied, which extend beyond the terms of this written warranty. Dr. Wellness Spas makes no warranty of merchantability of the goods or the fitness of goods for a particular purpose. No agent, dealer, service company, technician or other parts representative is authorized to change, modify, or extend the terms, make any promise of performance or make any other representation including implied warranties for merchantability and fitness for a particular purpose as well as non-infringement in any manner what so ever that are not included in the written warranties that accompany each Dr. Wellness Spa.

The MANUFACTURER'S liability, if any, shall not exceed the original amount paid for the original product. Under no circumstance shall the manufacturer or any of its representatives be liable for injury, loss, injury to person or damage to property, however arising, including indirect, punitive, special, incidental or consequential costs, expenses or damages, which may include, but are not limited to, loss of use, water damage, the removal of a permanent deck or other custom fixture whether the claim for such injury, loss, or damage is based on breach of contract, breach of warranty or tort, even if the MANUFACTURER has previously been advised of the possibility of damages.

This limited warranty gives you specific legal rights and you may have other rights which vary from state to state. Any disputes arising from the purchase of a Dr. Wellness Spa or this warranty are governed by the laws of the State of Tennessee.



Providing Therapy for Life

For help, please call 844-894-6659